

VEN

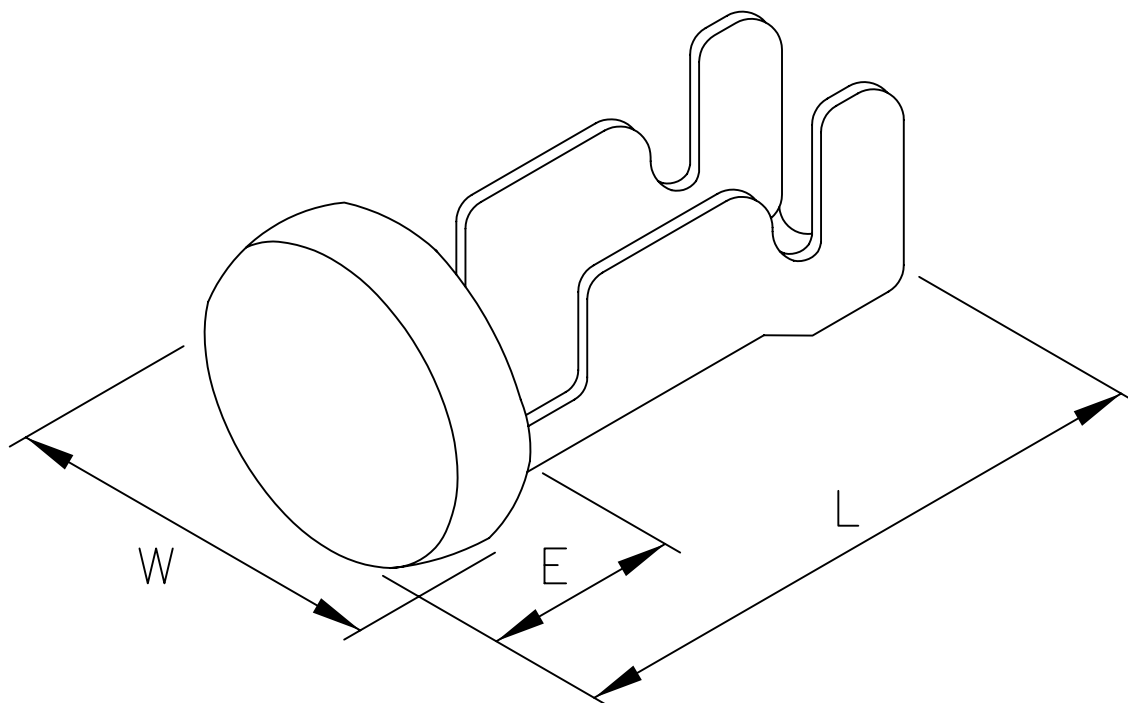

PART NO.	DIMENTION			WIRE RANGE		MATERIAL/ FINISH	STOCK THK	QTY/ RELL	N.W. Kgs	INSULATION O.D.mm
	W	E	L	AWG#	mm					
V1841BS-0	4.7	1.4	6.5	16-22	1.3-0.3	BRASS	0.4	10000	3.05	2.3-1.5
V1841BS-2	4.7	1.4	6.5	16-22	1.3-0.3	BRASS/TIN	0.4	10000	3.1	2.3-1.5