

VEN

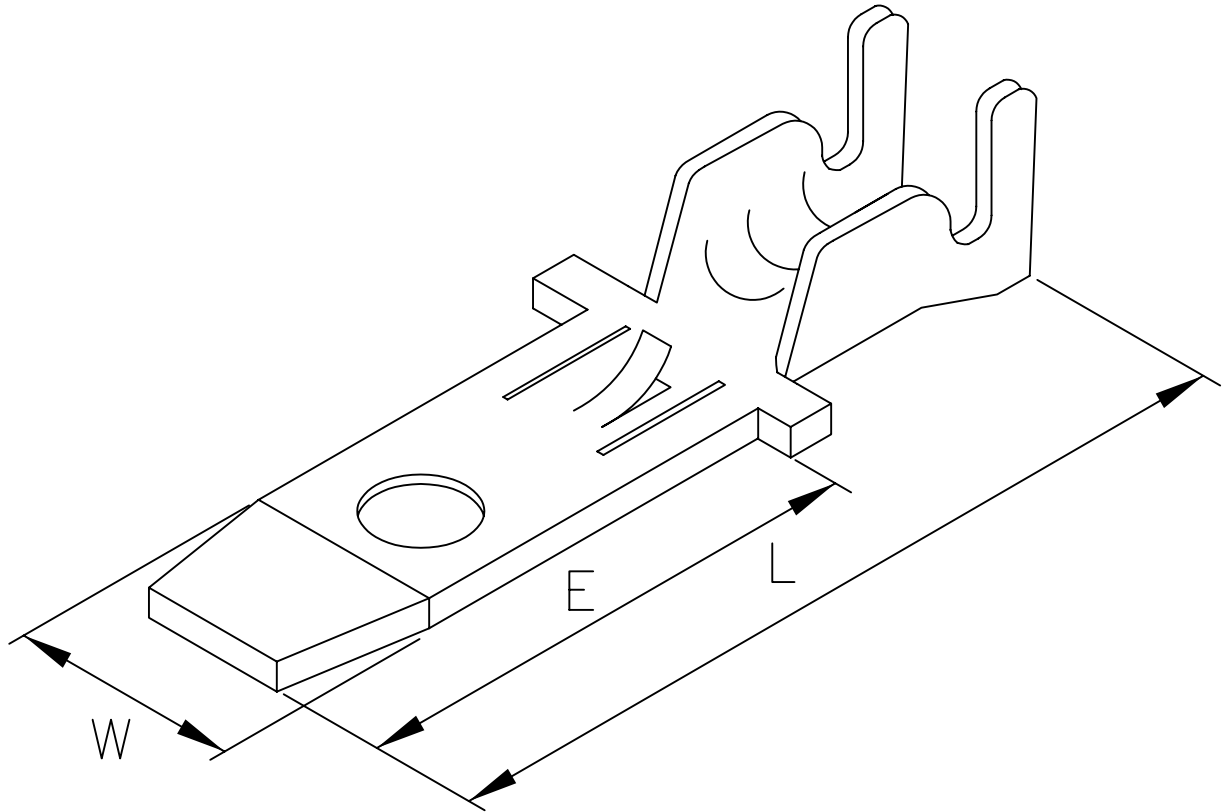

PART NO.	DIMENTION			WIRE RANGE		MATERIAL/ FINISH	STOCK THK	QTY/ RELL	N.W. Kgs	INSULATION O.D.mm
	W	E	L	AWG#	mm ²					
V1631BS-0	2.8	12.0	20.8	16-20	1.3-0.5	BRASS	0.5	10000	3.95	2.3-1.8
V1631BS-2	2.8	12.0	20.8	16-20	1.3-0.5	BRASS/TIN	0.5	10000	4.0	2.3-1.8