

VEN

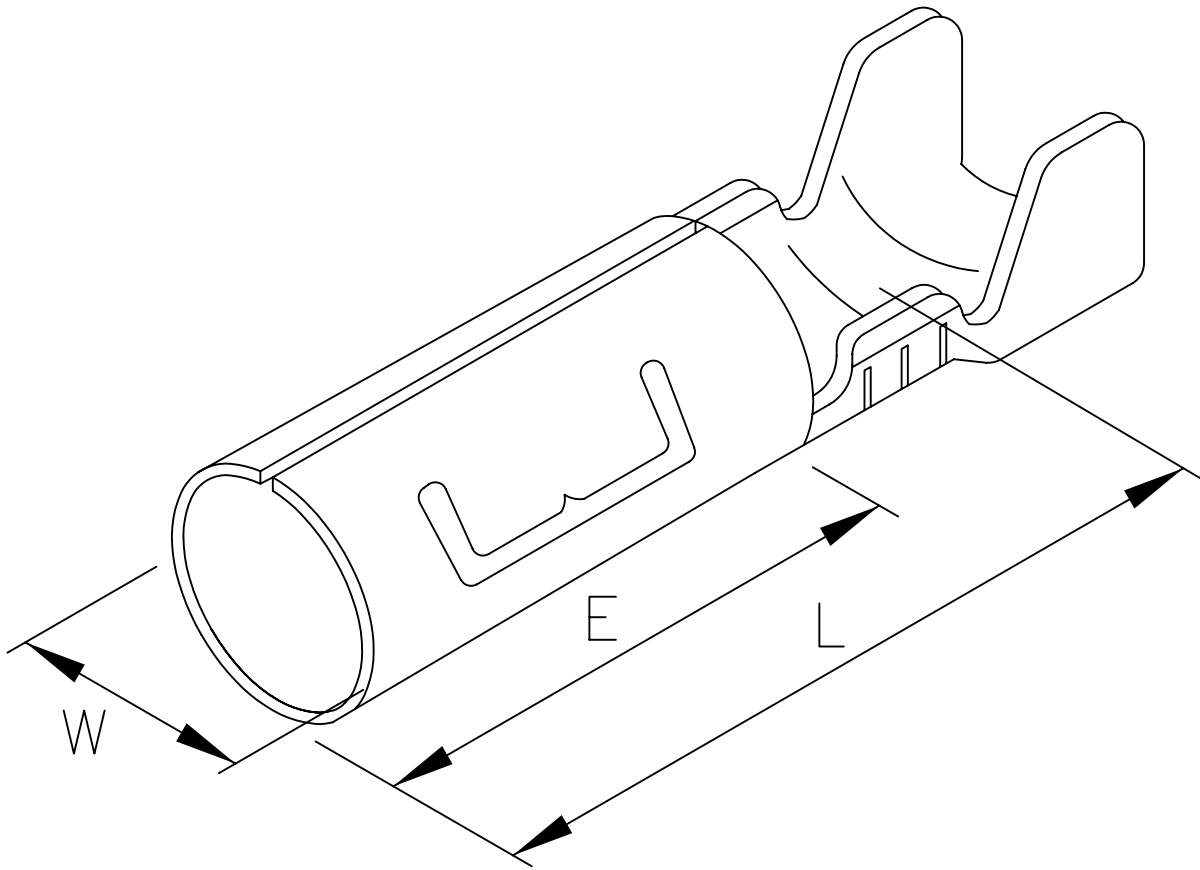

PART NO.	DIMENTION			WIRE RANGE		MATERIAL/ FINISH	STOCK THK	QTY/ RELL	N.W. Kgs	INSULATION O.D.mm
	W	E	L	AWG#	mm					
V1141BS-0	3.50	6.5	17.4	14-20	0.5-2.0	BRASS	0.4	10000	5.5	2.6-3.8
V1141BS-2	3.50	6.5	17.4	14-20	0.5-2.0	BRASS/TIN	0.4	10000	5.55	2.6-3.8
V1151BS-0	3.96	6.5	17.4	14-20	0.5-2.0	BRASS	0.4	7500	4.4	2.6-3.8
V1151BS-2	3.96	6.5	17.4	14-20	0.5-2.0	BRASS/TIN	0.4	7500	4.45	2.6-3.8